



Bridgelux® Gen 7 Vero® 18 Array Series

Product Data Sheet DSg2



BXRC-27x4000 | 30x4000 | 35x4000 | 40x4000 | 50x4001 | 57x4001 | 65x4001

Introduction

Vero



Vero represents a revolutionary advancement in chip on board (COB) light source technology and innovation. Vero LED light sources simplify luminaire design and manufacturing processes, improve light quality, and define a platform for future functionality integration.

Vero is available in four different light emitting surface (LES) configurations and has been engineered to reliably operate over a broad current range, enabling new degrees of flexibility in luminaire design optimization. Vero arrays deliver increased lumen density to enable improved beam control and precision lighting with 2 and 3 SDCM color control standard for clean and consistent uniform lighting.

Vero includes an on board connector port to enable solder free electrical interconnect and simple easy to use mounting features to enable plug-and-play installation.

Features

- Efficacy of 155 lm/W typical
- Vero 18 lumen output performance ranges from 2,044 to 13232 lumens
- Broad range of CCT options from 2700K to 5000K
- CRI options include minimum 70, 80, and 90, 2 and 3 SDCM color control for 2700K-4000K CCT
- Reliable operation at up to 2X nominal drive current
- Radial die pattern and improved lumen density
- Thermally isolated solder pads
- Onboard connector port
- Top side part number markings

Benefits

- Broad application coverage for interior and exterior lighting
- Flexibility for application driven lighting design requirements
- High quality true color reproduction
- Uniform consistent white light
- Flexibility in design optimization
- Improved optical control
- Enhanced ease of use and manufacturability
- Solderless connectivity enables plug & play installation and field upgradability
- Improved inventory management and quality control

Contents

Product Feature Map	2
Product Nomenclature	2
Product Selection Guide	3
Performance at Commonly Used Drive Currents	7
Electrical Characteristics	13
Absolute Maximum Ratings	14
Performance Curves	15
Typical Radiation Pattern	20
Typical Color Spectrum	21
Mechanical Dimensions	22
Color Binning Information	23
Packaging and Labeling	24
Design Resources	26
Precautions	26
Disclaimers	26
About Bridgelux	27

Product Selection Guide

The following product configurations are available:

Table 1: Selection Guide, Pulsed Measurement Data ($T_j = T_c = 25^\circ\text{C}$)

Part Number	Nominal CCT ¹ (K)	CRI ²	Nominal Drive Current ³ (mA)	Typical Pulsed Flux ^{4,5,6} $T_c = 25^\circ\text{C}$ (lm)	Minimum Pulsed Flux ^{6,7} $T_c = 25^\circ\text{C}$ (lm)	Typical V_f (V)	Typical Power (W)	Typical Efficacy (lm/W)
BXRC-27E4000-B-7X	2700	80	900	4644	4358	35.0	31.5	147
BXRC-27E4000-C-7X	2700	80	1170	6038	5555	35.0	41.0	147
BXRC-27E4000-D-7X	2700	80	1050	4515	4267	29.0	30.5	148
BXRC-27G4000-B-7X	2700	90	900	3870	3632	35.0	31.5	123
BXRC-27G4000-C-7X	2700	90	1170	5032	4629	35.0	41.0	123
BXRC-27G4000-D-7X	2700	90	1050	3763	3556	29.0	30.5	124
BXRC-30E4000-B-7X	3000	80	900	4883	4540	35.0	31.5	155
BXRC-30E4000-C-7X	3000	80	1170	6347	5787	35.0	41.0	155
BXRC-30E4000-D-7X	3000	80	1050	4720	4445	29.0	30.5	155
BXRC-30G4000-B-7X	3000	90	900	4015	3723	35.0	31.5	127
BXRC-30G4000-C-7X	3000	90	1170	5221	4803	35.0	41.0	127
BXRC-30G4000-D-7X	3000	90	1050	3904	3665	29.0	30.5	128
BXRC-35E4000-B-7X	3500	80	900	4983	4676	35.0	31.5	158
BXRC-35E4000-C-7X	3500	80	1170	6479	5960	35.0	41.0	158
BXRC-35E4000-D-7X	3500	80	1050	4845	4578	29.0	30.5	159
BXRC-35G4000-B-7X	3500	90	900	4160	3904	35.0	31.5	132
BXRC-35G4000-C-7X	3500	90	1170	5409	4977	35.0	41.0	132
BXRC-35G4000-D-7X	3500	90	1050	4045	3823	29.0	30.5	133
BXRC-40E4000-B-7X	4000	80	900	5031	4722	35.0	31.5	160
BXRC-40E4000-C-7X	4000	80	1170	6541	6018	35.0	41.0	160
BXRC-40E4000-D-7X	4000	80	1050	4892	4540	29.0	30.5	161
BXRC-40G4000-B-7X	4000	90	900	4305	4041	35.0	31.5	137
BXRC-40G4000-C-7X	4000	90	1170	5598	5150	35.0	41.0	137
BXRC-40G4000-D-7X	4000	90	1050	4186	3956	29.0	30.5	137
BXRC-50C4001-B-74	5000	70	900	5515	5176	35.0	31.5	175
BXRC-50C4001-C-74	5000	70	1170	7170	6597	35.0	41.0	175
BXRC-50C4001-D-74	5000	70	1050	5362	5060	29.0	30.5	176
BXRC-50E4001-B-74	5000	80	900	5184	4865	35.0	31.5	165
BXRC-50E4001-C-74	5000	80	1170	6740	6201	35.0	41.0	165
BXRC-50E4001-D-74	5000	80	1050	5040	4763	29.0	30.5	166

Notes for Tables 1:

1. Nominal CCT as defined by ANSI C78.377-2011. Products with CCTs 5000K-6500K are hot targeted to 85°C.
2. CRI values are minimums. Minimum R_g value for 80 CRI products is 0, the minimum R_g values for 90 CRI products is 50.
3. Drive current is referred to as nominal drive current.
4. Products tested under pulsed condition (10ms pulse width) at nominal test current where T_j (junction temperature) = T_c (case temperature) = 25°C.
5. Typical performance values are provided as a reference only and are not a guarantee of performance.
6. Bridgelux maintains a ±7% tolerance on flux measurements.
7. Minimum flux values at the nominal test current are guaranteed by 100% test.

Product Selection Guide

The following product configurations are available:

Table 1: Selection Guide, Pulsed Measurement Data ($T_j = T_c = 25^\circ\text{C}$) (continued)

Part Number	Nominal CCT ¹ (K)	CRI ²	Nominal Drive Current ³ (mA)	Typical Pulsed Flux ^{4,5,6} $T_c = 25^\circ\text{C}$ (lm)	Minimum Pulsed Flux ^{6,7} $T_c = 25^\circ\text{C}$ (lm)	Typical V_f (V)	Typical Power (W)	Typical Efficacy (lm/W)
BXRC-50G4001-B-74	5000	90	900	4412	4140	35.0	31.5	140
BXRC-50G4001-C-74	5000	90	1170	5736	5277	35.0	41.0	140
BXRC-50G4001-D-74	5000	90	1050	4290	4054	29.0	30.5	141
BXRC-57C4001-B-74	5700	70	900	5321	4994	35.0	31.5	169
BXRC-57C4001-C-74	5700	70	1170	6919	6365	35.0	41.0	169
BXRC-57C4001-D-74	5700	70	1050	5174	4890	29.0	30.5	170
BXRC-57E4001-B-74	5700	80	900	5273	4949	35.0	31.5	167
BXRC-57E4001-C-74	5700	80	1170	6856	6308	35.0	41.0	167
BXRC-57E4001-D-74	5700	80	1050	5127	4845	29.0	30.5	168
BXRC-65C4001-B-74	6500	70	900	5418	5085	35.0	31.5	172
BXRC-65C4001-C-74	6500	70	1170	7045	6481	35.0	41.0	172
BXRC-65C4001-D-74	6500	70	1050	5268	4978	29.0	30.5	173
BXRC-65E4001-B-74	6500	80	900	5370	5039	35.0	31.5	170
BXRC-65E4001-C-74	6500	80	1170	6982	6423	35.0	41.0	170
BXRC-65E4001-D-74	6500	80	1050	5221	4934	29.0	30.5	171

Notes for Tables 1:

1. Nominal CCT as defined by ANSI C78.377-2011. Products with a CCT of 5000K-6500K are hot targeted to 85°C.
2. CRI values are minimums. Minimum R_g value for 80 CRI products is 0, the minimum R_g values for 90 CRI products is 50.
3. Drive current is referred to as nominal drive current.
4. Products tested under pulsed condition (10ms pulse width) at nominal test current where T_j (junction temperature) = T_c (case temperature) = 25°C.
5. Typical performance values are provided as a reference only and are not a guarantee of performance.
6. Bridgelux maintains a ±7% tolerance on flux measurements.
7. Minimum flux values at the nominal test current are guaranteed by 100% test.

Product Selection Guide

Table 2: Selection Guide, Stabilized DC Performance ($T_c = 85^\circ\text{C}$)^{4,5}

Part Number	Nominal CCT ¹ (K)	CRI ²	Nominal Drive Current ³ (mA)	Typical DC Flux ^{4,5} $T_c = 85^\circ\text{C}$ (lm)	Minimum DC Flux ⁶ $T_c = 85^\circ\text{C}$ (lm)	Typical V_f (V)	Typical Power (W)	Typical Efficacy (lm/W)
BXRC-27E4000-B-7X	2700	80	900	4180	3923	34.1	30.7	136
BXRC-27E4000-C-7X	2700	80	1170	5434	5000	34.1	39.9	136
BXRC-27E4000-D-7X	2700	80	1050	4064	3840	28.3	29.7	137
BXRC-27G4000-B-7X	2700	90	900	3483	3269	34.1	30.7	113
BXRC-27G4000-C-7X	2700	90	1170	4529	4166	34.1	39.9	113
BXRC-27G4000-D-7X	2700	90	1050	3387	3200	28.3	29.7	114
BXRC-30E4000-B-7X	3000	80	900	4394	4086	34.1	30.7	143
BXRC-30E4000-C-7X	3000	80	1170	5713	5208	34.1	39.9	143
BXRC-30E4000-D-7X	3000	80	1050	4248	4001	28.3	29.7	143
BXRC-30G4000-B-7X	3000	90	900	3614	3351	34.1	30.7	118
BXRC-30G4000-C-7X	3000	90	1170	4699	4323	34.1	39.9	118
BXRC-30G4000-D-7X	3000	90	1050	3513	3299	28.3	29.7	118
BXRC-35E4000-B-7X	3500	80	900	4484	4208	34.1	30.7	146
BXRC-35E4000-C-7X	3500	80	1170	5831	5364	34.1	39.9	146
BXRC-35E4000-D-7X	3500	80	1050	4360	4121	28.3	29.7	147
BXRC-35G4000-B-7X	3500	90	900	3744	3514	34.1	30.7	122
BXRC-35G4000-C-7X	3500	90	1170	4868	4479	34.1	39.9	122
BXRC-35G4000-D-7X	3500	90	1050	3640	3440	28.3	29.7	123
BXRC-40E4000-B-7X	4000	80	900	4528	4250	34.1	30.7	148
BXRC-40E4000-C-7X	4000	80	1170	5887	5416	34.1	39.9	148
BXRC-40E4000-D-7X	4000	80	1050	4402	4086	28.3	29.7	148
BXRC-40G4000-B-7X	4000	90	900	3875	3637	34.1	30.7	126
BXRC-40G4000-C-7X	4000	90	1170	5038	4635	34.1	39.9	126
BXRC-40G4000-D-7X	4000	90	1050	3767	3560	28.3	29.7	127
BXRC-50C4001-B-74	5000	70	900	4963	4658	34.1	30.7	162
BXRC-50C4001-C-74	5000	70	1170	6453	5937	34.1	39.9	162
BXRC-50C4001-D-74	5000	70	1050	4826	4554	28.3	29.7	163
BXRC-50E4001-B-74	5000	80	900	4666	4379	34.1	30.7	152
BXRC-50E4001-C-74	5000	80	1170	6066	5581	34.1	39.9	152
BXRC-50E4001-D-74	5000	80	1050	4536	4287	28.3	29.7	153

Notes for Tables 2:

- Nominal CCT as defined by ANSI C78.377-2011. Products with a CCT of 5000K-6500K are hot targeted to 85°C.
- CRI values are minimums. Minimum Rg value for 80 CRI products is 0, the minimum Rg values for 90 CRI products is 50.
- Drive current is referred to as nominal drive current.
- Typical stabilized DC performance values are provided as reference only and are not a guarantee of performance.
- Typical performance is estimated based on operation under DC (direct current) with LED array mounted onto a heat sink with thermal interface material and the case temperature maintained at 85°C. Based on Bridgelux test setup, values may vary depending on the thermal design of the luminaire and/or the exposed environment to which the product is subjected.
- Minimum flux values at elevated temperatures are provided for reference only and are not guaranteed by 100% production testing. Based on Bridgelux test setup, values may vary depending on the thermal design of the luminaire and/or the exposed environment to which the product is subjected.

Product Selection Guide

Table 2: Selection Guide, Stabilized DC Performance ($T_c = 85^\circ\text{C}$)^{4,5} (continued)

Part Number	Nominal CCT ¹ (K)	CRI ²	Nominal Drive Current ³ (mA)	Typical DC Flux ^{4,5} $T_c = 85^\circ\text{C}$ (lm)	Minimum DC Flux ⁶ $T_c = 85^\circ\text{C}$ (lm)	Typical V_f (V)	Typical Power (W)	Typical Efficacy (lm/W)
BXRC-50G4001-B-74	5000	90	900	3971	3726	34.1	30.7	129
BXRC-50G4001-C-74	5000	90	1170	5163	4750	34.1	39.9	129
BXRC-50G4001-D-74	5000	90	1050	3861	3648	28.3	29.7	130
BXRC-57C4001-B-74	5700	70	900	4789	4495	34.1	30.7	156
BXRC-57C4001-C-74	5700	70	1170	6227	5729	34.1	39.9	156
BXRC-57C4001-D-74	5700	70	1050	4656	4401	28.3	29.7	157
BXRC-57E4001-B-74	5700	80	900	4746	4454	34.1	30.7	155
BXRC-57E4001-C-74	5700	80	1170	6170	5677	34.1	39.9	155
BXRC-57E4001-D-74	5700	80	1050	4614	4361	28.3	29.7	155
BXRC-65C4001-B-74	6500	70	900	4876	4576	34.1	30.7	159
BXRC-65C4001-C-74	6500	70	1170	6340	5833	34.1	39.9	159
BXRC-65C4001-D-74	6500	70	1050	4741	4481	28.3	29.7	160
BXRC-65E4001-B-74	6500	80	900	4833	4535	34.1	30.7	157
BXRC-65E4001-C-74	6500	80	1170	6284	5781	34.1	39.9	157
BXRC-65E4001-D-74	6500	80	1050	4699	4441	28.3	29.7	158

Notes for Tables 2:

1. Nominal CCT as defined by ANSI C78.377-2011. Products with a CCT of 5000K-6500K are hot targeted to 85°C.
2. CRI values are minimums. Minimum R9 value for 80 CRI products is 0, the minimum R9 values for 90 CRI products is 50.
3. Drive current is referred to as nominal drive current.
4. Typical stabilized DC performance values are provided as reference only and are not a guarantee of performance.
5. Typical performance is estimated based on operation under DC (direct current) with LED array mounted onto a heat sink with thermal interface material and the case temperature maintained at 85°C. Based on Bridgelux test setup, values may vary depending on the thermal design of the luminaire and/or the exposed environment to which the product is subjected.
6. Minimum flux values at elevated temperatures are provided for reference only and are not guaranteed by 100% production testing. Based on Bridgelux test setup, values may vary depending on the thermal design of the luminaire and/or the exposed environment to which the product is subjected.

Performance at Commonly Used Drive Currents

Vero LED arrays are tested to the specifications shown using the nominal drive currents in Table 1. Vero may also be driven at other drive currents dependent on specific application design requirements. The performance at any drive current can be derived from the current vs. voltage characteristics shown in Figures 1, 2 & 3 and the flux vs. current characteristics shown in Figures 4, 5 & 6. The performance at commonly used drive currents is summarized in Table 3.

Table 3: Product Performance at Commonly Used Drive Currents

Part Number	CRI	Drive Current ¹ (mA)	Typical V _f T _c = 25°C (V)	Typical Power T _c = 25°C (W)	Typical Flux ² T _c = 25°C (lm)	Typical DC Flux ³ T _c = 85°C (lm)	Typical Efficacy T _c = 25°C (lm/W)
BXRC-27E4000-B-7X	80	450	33.3	15.0	2493	2241	166
		600	33.9	20.4	3271	2934	161
		900	35.0	31.5	4644	4180	147
		1350	36.7	49.5	6907	6086	140
		1800	38.0	68.4	8888	7726	130
BXRC-27E4000-C-7X	80	585	33.4	19.5	3155	2986	162
		780	34.0	26.5	4134	3831	156
		1170	35.0	41.0	6038	5434	147
		1755	36.8	64.5	8687	7646	135
		2340	38.1	89.3	11143	9604	125
BXRC-27E4000-D-7X	80	525	27.7	14.6	2405	2233	165
		700	28.2	19.8	3128	2866	158
		1050	29.0	30.5	4515	4064	148
		1575	30.4	47.9	6450	5703	135
		2100	31.5	66.2	8210	7140	124
BXRC-27G4000-B-7X	90	450	33.3	15.0	2078	1867	139
		600	33.9	20.4	2726	2445	134
		900	35.0	31.5	3870	3483	123
		1350	36.7	49.5	5756	5071	116
		1800	38.0	68.4	7407	6439	108
BXRC-27G4000-C-7X	90	585	33.4	19.5	2629	2488	135
		780	34.0	26.5	3445	3193	130
		1170	35.0	41.0	5032	4529	123
		1755	36.8	64.5	7239	6371	112
		2340	38.1	89.3	9286	8003	104
BXRC-27G4000-D-7X	90	525	27.7	14.6	2004	1861	138
		700	28.2	19.8	2606	2389	132
		1050	29.0	30.5	3763	3387	124
		1575	30.4	47.9	5375	4753	112
		2100	31.5	66.2	6842	5950	103

Notes for Table 3:

1. Alternate drive currents in Table 3 are provided for reference only and are not a guarantee of performance.
2. Bridgelux maintains a ± 7% tolerance on flux measurements.
3. Typical stabilized DC performance values are provided as reference only and are not a guarantee of performance.

Performance at Commonly Used Drive Currents

Table 3: Product Performance at Commonly Used Drive Currents (Continued)

Part Number	CRI	Drive Current ¹ (mA)	Typical V_f $T_c = 25^\circ\text{C}$ (V)	Typical Power $T_c = 25^\circ\text{C}$ (W)	Typical Flux ² $T_c = 25^\circ\text{C}$ (lm)	Typical DC Flux ³ $T_c = 85^\circ\text{C}$ (lm)	Typical Efficacy $T_c = 25^\circ\text{C}$ (lm/W)
BXRC-30E4000-B-7X	80	450	33.3	15.0	2621	2356	175
		600	33.9	20.4	3439	3084	169
		900	35.0	31.5	4883	4394	155
		1350	36.7	49.5	7262	6398	147
		1800	38.0	68.4	9345	8123	137
BXRC-30E4000-C-7X	80	585	33.4	19.5	3316	3139	170
		780	34.0	26.5	4346	4027	164
		1170	35.0	41.0	6347	5713	155
		1755	36.8	64.5	9131	8037	142
		2340	38.1	89.3	11713	10095	131
BXRC-30E4000-D-7X	80	525	27.7	14.6	2514	2334	173
		700	28.2	19.8	3269	2996	165
		1050	29.0	30.5	4720	4248	155
		1575	30.4	47.9	6741	5961	141
		2100	31.5	66.2	8582	7463	130
BXRC-30G4000-B-7X	90	450	33.3	15.0	2156	1937	144
		600	33.9	20.4	2828	2536	139
		900	35.0	31.5	4015	3614	127
		1350	36.7	49.5	5972	5262	121
		1800	38.0	68.4	7685	6680	112
BXRC-30G4000-C-7X	90	585	33.4	19.5	2728	2581	140
		780	34.0	26.5	3574	3312	135
		1170	35.0	41.0	5221	4699	127
		1755	36.8	64.5	7510	6610	116
		2340	38.1	89.3	9634	8303	108
BXRC-30G4000-D-7X	90	525	27.7	14.6	2080	1930	143
		700	28.2	19.8	2704	2478	137
		1050	29.0	30.5	3904	3513	128
		1575	30.4	47.9	5576	4931	116
		2100	31.5	66.2	7098	6173	107
BXRC-35E4000-B-7X	80	450	33.3	15.0	2675	2404	178
		600	33.9	20.4	3509	3148	172
		900	35.0	31.5	4983	4484	158
		1350	36.7	49.5	7411	6530	150
		1800	38.0	68.4	9536	8290	139
BXRC-35E4000-C-7X	80	585	33.4	19.5	3385	3203	173
		780	34.0	26.5	4436	4111	167
		1170	35.0	41.0	6479	5831	158
		1755	36.8	64.5	9320	8203	144
		2340	38.1	89.3	11955	10304	134
BXRC-35E4000-D-7X	80	525	27.7	14.6	2581	2395	177
		700	28.2	19.8	3356	3075	170
		1050	29.0	30.5	4845	4360	159
		1575	30.4	47.9	6920	6119	144
		2100	31.5	66.2	8809	7660	133

Notes for Table 3:

1. Alternate drive currents in Table 3 are provided for reference only and are not a guarantee of performance.
2. Bridgelux maintains a $\pm 7\%$ tolerance on flux measurements.
3. Typical stabilized DC performance values are provided as reference only and are not a guarantee of performance.

Performance at Commonly Used Drive Currents

Table 3: Product Performance at Commonly Used Drive Currents (Continued)

Part Number	CRI	Drive Current ¹ (mA)	Typical V _f T _c = 25°C (V)	Typical Power T _c = 25°C (W)	Typical Flux ² T _c = 25°C (lm)	Typical DC Flux ³ T _c = 85°C (lm)	Typical Efficacy T _c = 25°C (lm/W)
BXRC-35G4000-B-7X	90	450	33.3	15.0	2234	2007	149
		600	33.9	20.4	2930	2628	144
		900	35.0	31.5	4160	3744	132
		1350	36.7	49.5	6188	5452	125
		1800	38.0	68.4	7962	6921	116
BXRC-35G4000-C-7X	90	585	33.4	19.5	2826	2675	145
		780	34.0	26.5	3704	3432	140
		1170	35.0	41.0	5409	4868	132
		1755	36.8	64.5	7782	6849	121
		2340	38.1	89.3	9982	8603	112
BXRC-35G4000-D-7X	90	525	27.7	14.6	2155	2000	148
		700	28.2	19.8	2802	2568	142
		1050	29.0	30.5	4045	3640	133
		1575	30.4	47.9	5778	5109	121
		2100	31.5	66.2	7355	6396	111
BXRC-40E4000-B-7X	80	450	33.3	15.0	2701	2427	180
		600	33.9	20.4	3543	3178	174
		900	35.0	31.5	5031	4528	160
		1350	36.7	49.5	7483	6593	151
		1800	38.0	68.4	9629	8370	141
BXRC-40E4000-C-7X	80	585	33.4	19.5	3418	3235	175
		780	34.0	26.5	4479	4151	169
		1170	35.0	41.0	6541	5887	160
		1755	36.8	64.5	9411	8283	146
		2340	38.1	89.3	12071	10404	135
BXRC-40E4000-D-7X	80	525	27.7	14.6	2606	2419	179
		700	28.2	19.8	3388	3105	171
		1050	29.0	30.5	4892	4402	161
		1575	30.4	47.9	6987	6178	146
		2100	31.5	66.2	8894	7735	134
BXRC-40G4000-B-7X	90	450	33.3	15.0	2312	2077	154
		600	33.9	20.4	3032	2720	149
		900	35.0	31.5	4305	3875	137
		1350	36.7	49.5	6403	5642	129
		1800	38.0	68.4	8240	7163	120
BXRC-40G4000-C-7X	90	585	33.4	19.5	2925	2768	150
		780	34.0	26.5	3833	3552	145
		1170	35.0	41.0	5598	5038	137
		1755	36.8	64.5	8053	7088	125
		2340	38.1	89.3	10330	8903	116
BXRC-40G4000-D-7X	90	525	27.7	14.6	2230	2070	153
		700	28.2	19.8	2900	2657	147
		1050	29.0	30.5	4186	3767	137
		1575	30.4	47.9	5979	5287	125
		2100	31.5	66.2	7612	6619	115

Notes for Table 3:

1. Alternate drive currents in Table 3 are provided for reference only and are not a guarantee of performance.
2. Bridgelux maintains a ± 7% tolerance on flux measurements.
3. Typical stabilized DC performance values are provided as reference only and are not a guarantee of performance.

Performance at Commonly Used Drive Currents

Table 3: Product Performance at Commonly Used Drive Currents (Continued)

Part Number	CRI	Drive Current ¹ (mA)	Typical V_f $T_c = 25^\circ\text{C}$ (V)	Typical Power $T_c = 25^\circ\text{C}$ (W)	Typical Flux ² $T_c = 25^\circ\text{C}$ (lm)	Typical DC Flux ³ $T_c = 85^\circ\text{C}$ (lm)	Typical Efficacy $T_c = 25^\circ\text{C}$ (lm/W)
BXRC-50C4001-B-74	70	450	33.3	15.0	2961	2661	197
		600	33.9	20.4	3884	3484	191
		900	35.0	31.5	5515	4963	175
		1350	36.7	49.5	8202	7227	166
		1800	38.0	68.4	10555	9175	154
BXRC-50C4001-C-74	70	585	33.4	19.5	3746	3546	192
		780	34.0	26.5	4909	4550	185
		1170	35.0	41.0	7170	6453	175
		1755	36.8	64.5	10315	9079	160
		2340	38.1	89.3	13232	11404	148
BXRC-50C4001-D-74	70	525	27.7	14.6	2856	2651	196
		700	28.2	19.8	3714	3404	188
		1050	29.0	30.5	5362	4826	176
		1575	30.4	47.9	7659	6772	160
		2100	31.5	66.2	9750	8478	147
BXRC-50E4001-B-74	80	450	33.3	15.0	2783	2501	186
		600	33.9	20.4	3651	3275	179
		900	35.0	31.5	5184	4666	165
		1350	36.7	49.5	7710	6793	156
		1800	38.0	68.4	9922	8624	145
BXRC-50E4001-C-74	80	585	33.4	19.5	3522	3333	180
		780	34.0	26.5	4615	4277	174
		1170	35.0	41.0	6740	6066	165
		1755	36.8	64.5	9697	8535	150
		2340	38.1	89.3	12438	10720	139
BXRC-50E4001-D-74	80	525	27.7	14.6	2685	2492	184
		700	28.2	19.8	3491	3200	177
		1050	29.0	30.5	5040	4536	166
		1575	30.4	47.9	7199	6366	150
		2100	31.5	66.2	9165	7970	138
BXRC-50G4001-B-74	90	450	33.3	15.0	2369	2128	158
		600	33.9	20.4	3107	2787	153
		900	35.0	31.5	4412	3971	140
		1350	36.7	49.5	6562	5782	133
		1800	38.0	68.4	8444	7340	123
BXRC-50G4001-C-74	90	585	33.4	19.5	2997	2836	154
		780	34.0	26.5	3928	3640	148
		1170	35.0	41.0	5736	5163	140
		1755	36.8	64.5	8252	7263	128
		2340	38.1	89.3	10585	9124	119
BXRC-50G4001-D-74	90	525	27.7	14.6	2285	2121	157
		700	28.2	19.8	2971	2723	150
		1050	29.0	30.5	4290	3861	141
		1575	30.4	47.9	6127	5418	128
		2100	31.5	66.2	7800	6783	118

Notes for Table 3:

1. Alternate drive currents in Table 3 are provided for reference only and are not a guarantee of performance.
2. Bridgelux maintains a $\pm 7\%$ tolerance on flux measurements.
3. Typical stabilized DC performance values are provided as reference only and are not a guarantee of performance.

Performance at Commonly Used Drive Currents

Table 3: Product Performance at Commonly Used Drive Currents (Continued)

Part Number	CRI	Drive Current ¹ (mA)	Typical V_f $T_c = 25^\circ\text{C}$ (V)	Typical Power $T_c = 25^\circ\text{C}$ (W)	Typical Flux ² $T_c = 25^\circ\text{C}$ (lm)	Typical DC Flux ³ $T_c = 85^\circ\text{C}$ (lm)	Typical Efficacy $T_c = 25^\circ\text{C}$ (lm/W)
BXRC-57C4001-B-74	70	450	33.3	15.0	2857	2567	190
		600	33.9	20.4	3748	3361	184
		900	35.0	31.5	5321	4789	169
		1350	36.7	49.5	7914	6973	160
		1800	38.0	68.4	10184	8853	149
BXRC-57C4001-C-74	70	585	33.4	19.5	3615	3421	185
		780	34.0	26.5	4737	4390	179
		1170	35.0	41.0	6919	6227	169
		1755	36.8	64.5	9954	8761	154
		2340	38.1	89.3	12768	11004	143
BXRC-57C4001-D-74	70	525	27.7	14.6	2756	2558	189
		700	28.2	19.8	3584	3284	181
		1050	29.0	30.5	5174	4656	170
		1575	30.4	47.9	7390	6535	154
		2100	31.5	66.2	9408	8181	142
BXRC-57E4001-B-74	80	450	33.3	15.0	2831	2544	189
		600	33.9	20.4	3714	3331	182
		900	35.0	31.5	5273	4746	167
		1350	36.7	49.5	7842	6910	158
		1800	38.0	68.4	10092	8773	147
BXRC-57E4001-C-74	80	585	33.4	19.5	3582	3390	184
		780	34.0	26.5	4694	4350	177
		1170	35.0	41.0	6856	6170	167
		1755	36.8	64.5	9863	8681	153
		2340	38.1	89.3	12651	10904	142
BXRC-57E4001-D-74	80	525	27.7	14.6	2731	2535	188
		700	28.2	19.8	3551	3254	180
		1050	29.0	30.5	5127	4614	168
		1575	30.4	47.9	7323	6475	153
		2100	31.5	66.2	9322	8106	141
BXRC-65C4001-B-74	70	450	33.3	15.0	2909	2614	194
		600	33.9	20.4	3816	3423	187
		900	35.0	31.5	5418	4876	172
		1350	36.7	49.5	8058	7100	163
		1800	38.0	68.4	10370	9014	151
BXRC-65C4001-C-74	70	585	33.4	19.5	3681	3483	189
		780	34.0	26.5	4823	4470	182
		1170	35.0	41.0	7045	6340	172
		1755	36.8	64.5	10134	8920	157
		2340	38.1	89.3	13000	11204	146
BXRC-65C4001-D-74	70	525	27.7	14.6	2806	2605	193
		700	28.2	19.8	3649	3344	185
		1050	29.0	30.5	5268	4741	173
		1575	30.4	47.9	7524	6654	157
		2100	31.5	66.2	9579	8330	145

Notes for Table 3:

1. Alternate drive currents in Table 3 are provided for reference only and are not a guarantee of performance.
2. Bridgelux maintains a $\pm 7\%$ tolerance on flux measurements.
3. Typical stabilized DC performance values are provided as reference only and are not a guarantee of performance.

Performance at Commonly Used Drive Currents

Table 3: Product Performance at Commonly Used Drive Currents (Continued)

Part Number	CRI	Drive Current ¹ (mA)	Typical V_f $T_c = 25^\circ\text{C}$ (V)	Typical Power $T_c = 25^\circ\text{C}$ (W)	Typical Flux ² $T_c = 25^\circ\text{C}$ (lm)	Typical DC Flux ³ $T_c = 85^\circ\text{C}$ (lm)	Typical Efficacy $T_c = 25^\circ\text{C}$ (lm/W)
BXRC-65E4001-B-74	80	450	33.3	15.0	2883	2591	192
		600	33.9	20.4	3782	3392	186
		900	35.0	31.5	5370	4833	170
		1350	36.7	49.5	7986	7037	161
		1800	38.0	68.4	10277	8934	150
BXRC-65E4001-C-74	80	585	33.4	19.5	3648	3452	187
		780	34.0	26.5	4780	4430	180
		1170	35.0	41.0	6982	6284	170
		1755	36.8	64.5	10044	8840	156
		2340	38.1	89.3	12884	11104	144
BXRC-65E4001-D-74	80	525	27.7	14.6	2781	2581	191
		700	28.2	19.8	3616	3314	183
		1050	29.0	30.5	5221	4699	171
		1575	30.4	47.9	7457	6594	156
		2100	31.5	66.2	9493	8255	143

Notes for Table 3:

1. Alternate drive currents in Table 3 are provided for reference only and are not a guarantee of performance.
2. Bridgelux maintains a $\pm 7\%$ tolerance on flux measurements.
3. Typical stabilized DC performance values are provided as reference only and are not a guarantee of performance.

Electrical Characteristics

Table 4: Electrical Characteristics

Part Number	Drive Current (mA)	Forward Voltage Pulsed, $T_c = 25^\circ\text{C}$ (V) ^{1, 2, 3, 8}			Typical Coefficient of Forward Voltage ⁴ $\Delta V_f / \Delta T_c$ (mV/ $^\circ\text{C}$)	Typical Thermal Resistance Junction to Case ^{5,6} R_{j-c} ($^\circ\text{C}/\text{W}$)	Driver Selection Voltages ⁷ (V)	
		Minimum	Typical	Maximum			V_f Min. Hot $T_c = 105^\circ\text{C}$ (V)	V_f Max. Cold $T_c = -40^\circ\text{C}$ (V)
BXRC-xxx400x-B-7x	900	32.4	35.0	37.6	-14.9	0.15	31.2	38.6
	1800	35.2	38.0	40.9	-14.9	0.19	34.0	41.8
BXRC-xxx400x-C-7x	1170	32.4	35.0	37.6	-12.2	0.11	31.4	38.4
	2340	35.3	38.1	41.0	-14.9	0.13	34.1	42.0
BXRC-xxx400x-D-7x	1050	26.8	29.0	31.2	-14.9	0.16	25.6	32.1
	2100	29.2	31.5	33.9	-12.2	0.19	28.2	34.7

Notes for Table 4:

1. Parts are tested in pulsed conditions, $T_c = 25^\circ\text{C}$. Pulse width is 10ms.
2. Voltage minimum and maximum are provided for reference only and are not a guarantee of performance.
3. Bridgelux maintains a tester tolerance of $\pm 0.10\text{V}$ on forward voltage measurements.
4. Typical coefficient of forward voltage tolerance is $\pm 0.1\text{mV}$ for nominal current.
5. Thermal resistance values are based from test data of a 3000K 80 CRI product.
6. Thermal resistance value was calculated using total electrical input power; optical power was not subtracted from input power. The thermal interface material used during testing is not included in the thermal resistance value.
7. V_f min hot and max cold values are provided as reference only and are not guaranteed by test. These values are provided to aid in driver design and selection over the operating range of the product.
8. This product has been designed and manufactured per IEC 62031:2014. This product has passed dielectric withstand voltage testing at 1120 V. The working voltage designated for the insulation is 60V d.c. The maximum allowable voltage across the array must be determined in the end product application.

Absolute Maximum Ratings

Table 5: Maximum Ratings

Parameter	Maximum Rating		
LED Junction Temperature (T _j)	125°C		
Storage Temperature	-40°C to +105°C		
Operating Case Temperature ¹ (T _c)	105°C		
Soldering Temperature ²	350°C or lower for a maximum of 10seconds		
	BXRC-xxx400x-B-7x	BXRC-xxx400x-C-7x	BXRC-xxx400x-D-7x
Maximum Drive Current ³	1800mA	2340mA	2100mA
Maximum Peak Pulsed Drive Current ⁴	2571mA	3343mA	3000mA
Maximum Reverse Voltage ⁵	-60V	-60V	-50V

Notes for Table 5:

1. For IEC 62717 requirement, please consult your Bridgelux sales representative.
2. Refer to Bridgelux Application Note AN31: Assembly Considerations for Bridgelux Vero LED Arrays.
3. Arrays may be driven at higher currents however lumen maintenance may be reduced.
4. Bridgelux recommends a maximum duty cycle of 10% and pulse width of 20 ms when operating LED Arrays at maximum peak pulsed current specified. Maximum peak pulsed currents indicate values where LED Arrays can be driven without catastrophic failures.
5. Light emitting diodes are not designed to be driven in reverse voltage and will not produce light under this condition. Maximum rating provided for reference only.

Performance Curves

Figure 1: Vero 18B Drive Current vs. Voltage ($T_j = T_c = 25^\circ\text{C}$)

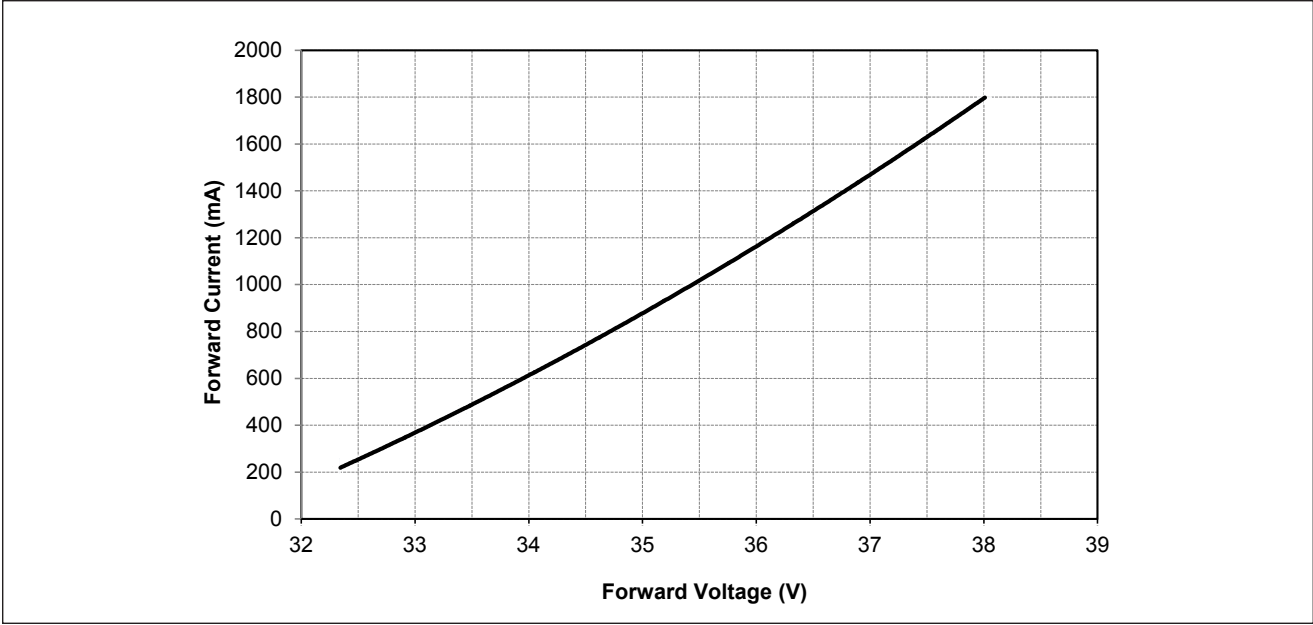
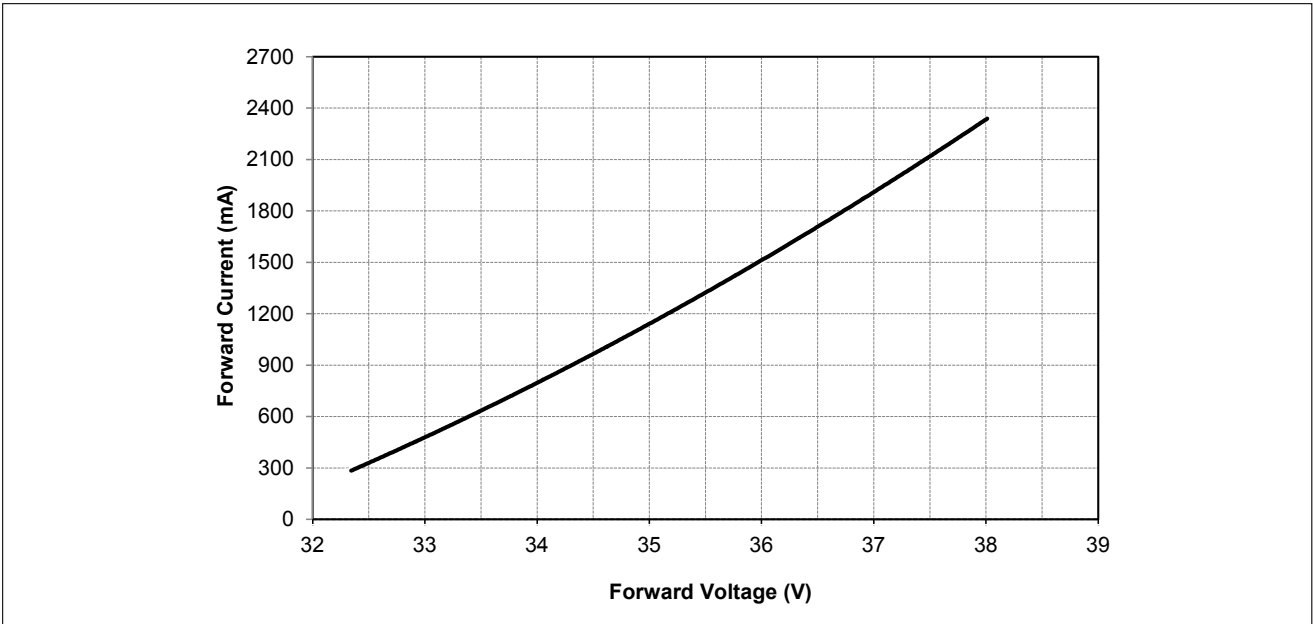

Figure 2: Vero 18C Drive Current vs. Voltage ($T_j = T_c = 25^\circ\text{C}$)



Performance Curves

Figure 3: Vero 18D Drive Current vs. Voltage ($T_j = T_c = 25^\circ\text{C}$)

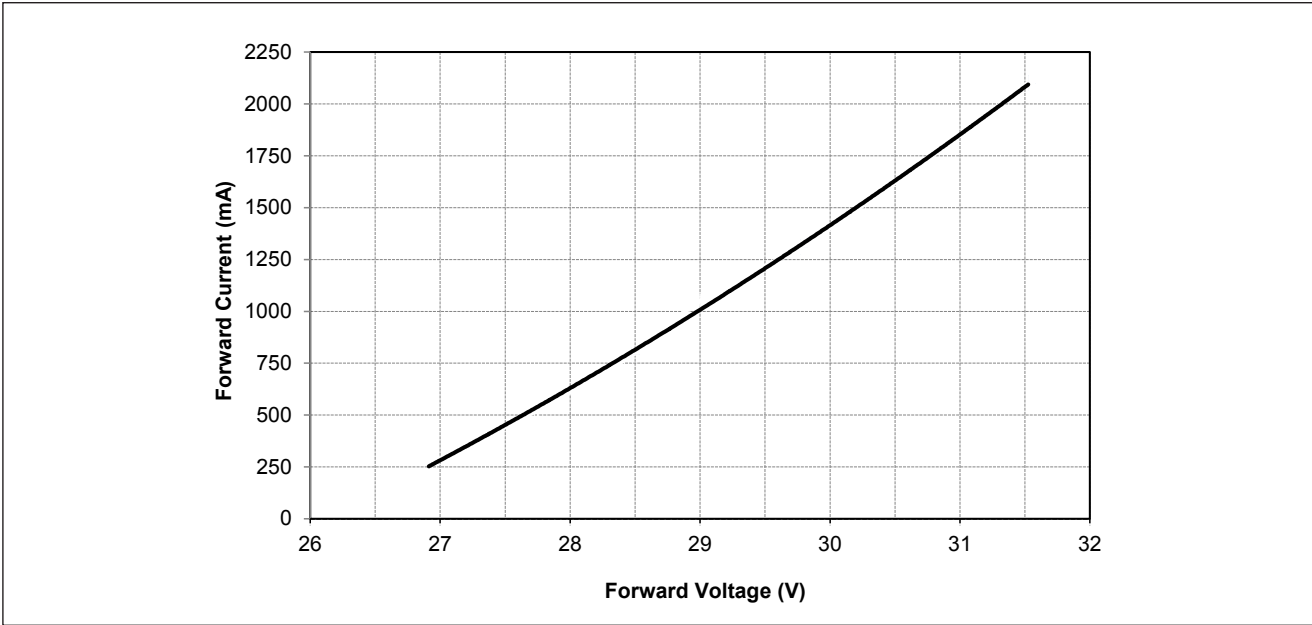
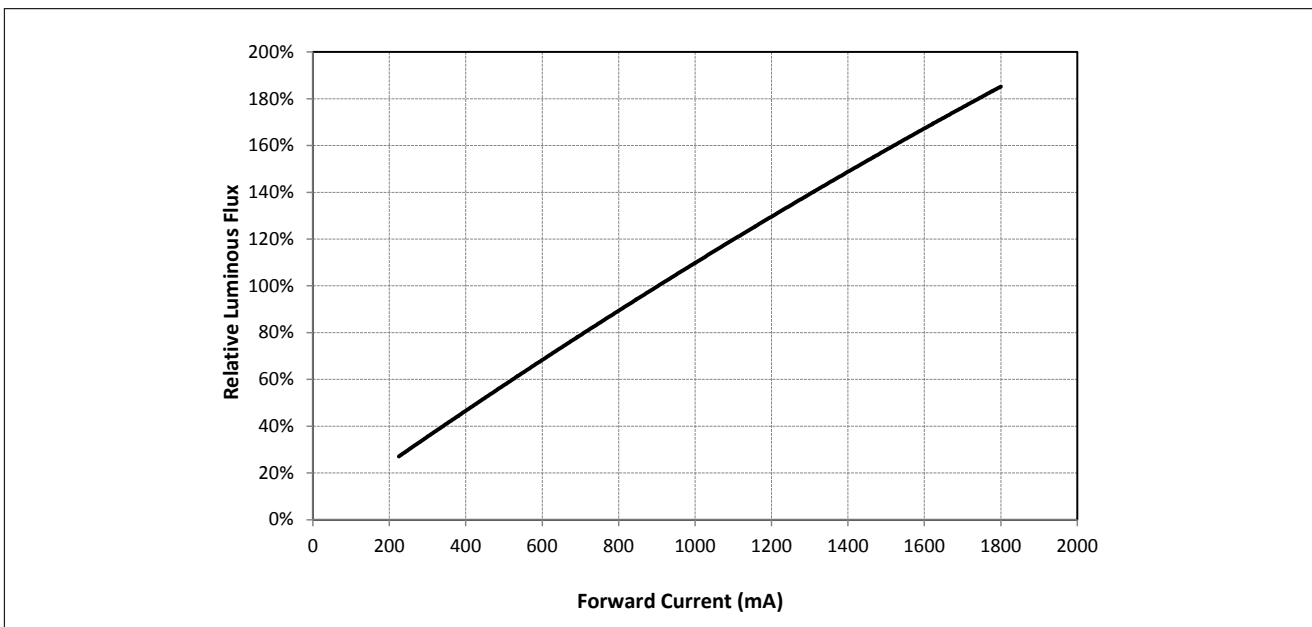

Figure 4: Vero 18B Typical Relative Flux vs. Current ($T_j = T_c = 25^\circ\text{C}$)



Note for Figure 4:

1. Bridgelux does not recommend driving high power LEDs at low currents. Doing so may produce unpredictable results. Pulse width modulation (PWM) is recommended for dimming effects.

Performance Curves

Figure 5: Vero 18C Typical Relative Flux vs. Current ($T_j = T_c = 25^\circ\text{C}$)

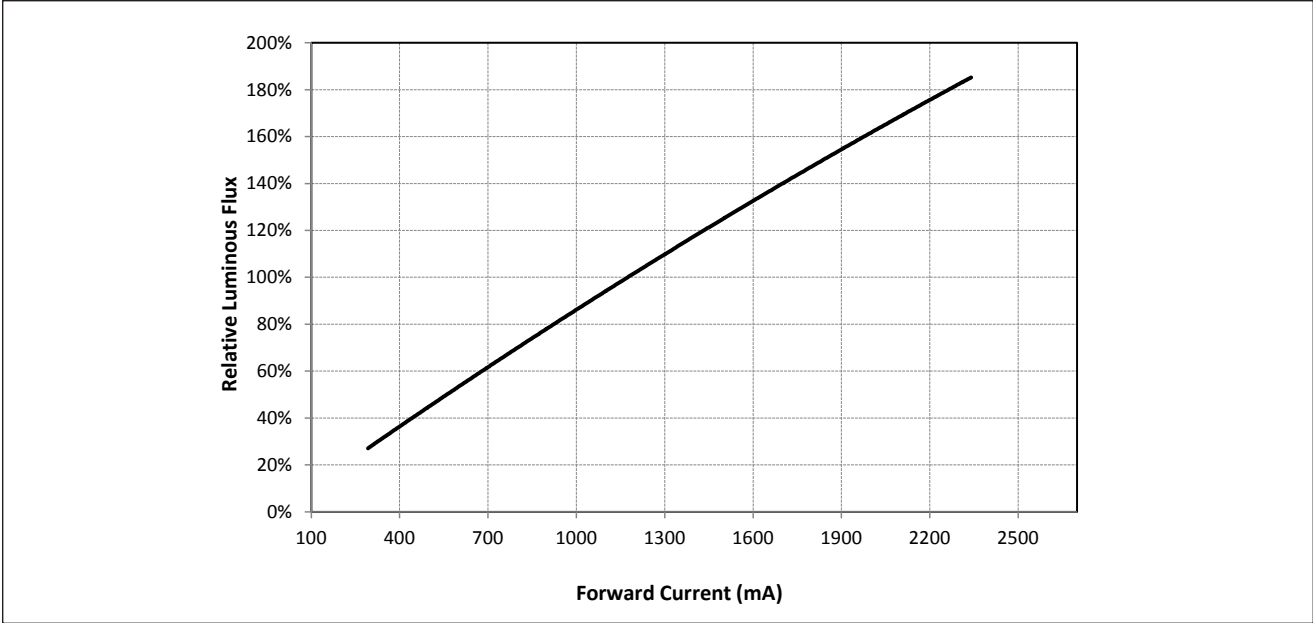
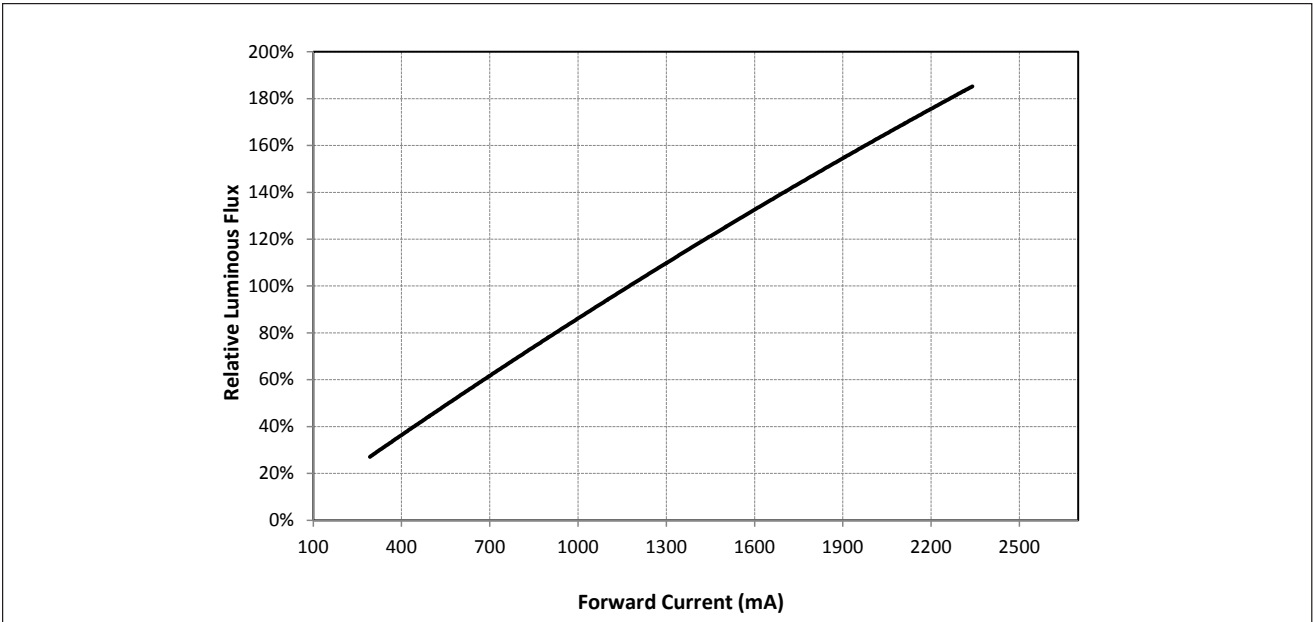

Figure 6 Vero 18D Typical Relative Flux vs. Current ($T_j = T_c = 25^\circ\text{C}$)



Note for Figures 5 & 6:

- 1. Bridgelux does not recommend driving high power LEDs at low currents. Doing so may produce unpredictable results. Pulse width modulation (PWM) is recommended for dimming effects.

Performance Curves

Figure 7: Typical DC Flux vs. Case Temperature

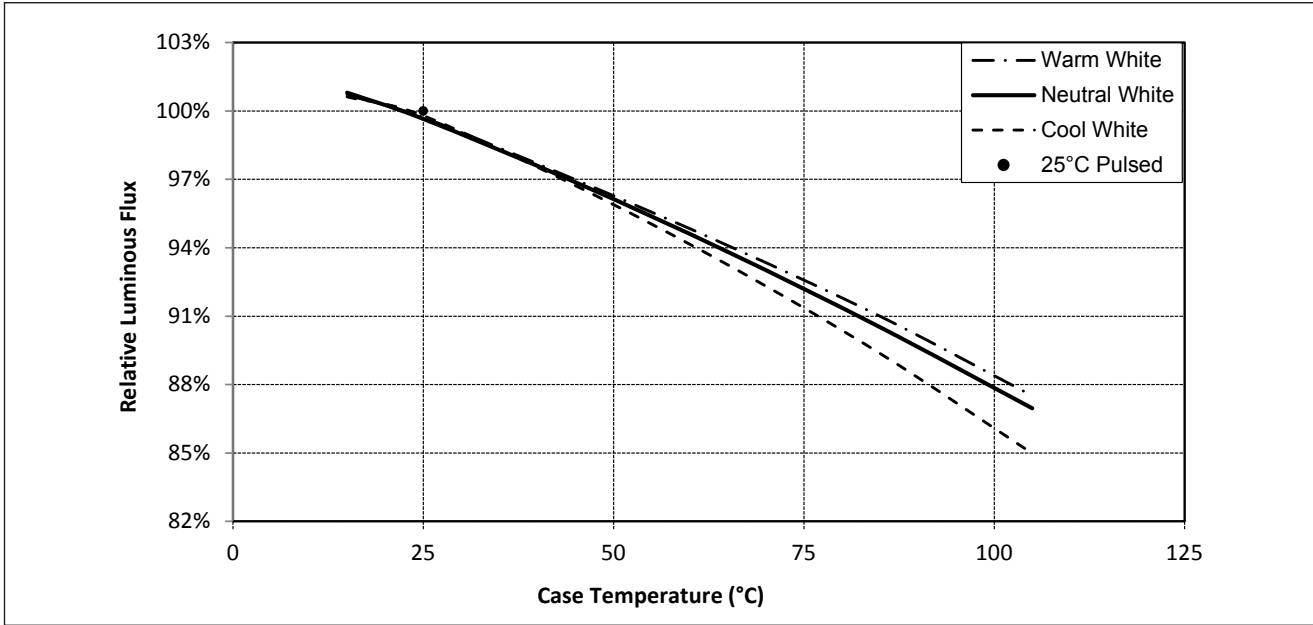
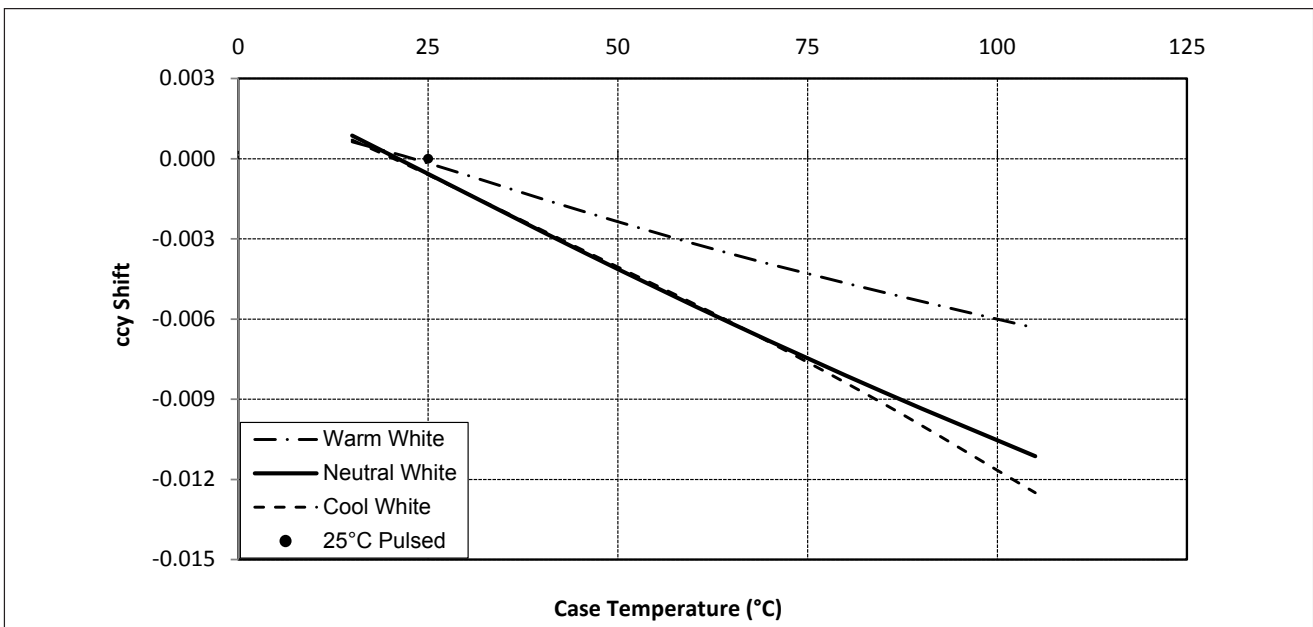

Figure 8: Typical DC ccy Shift vs. Case Temperature



Notes for Figures 7 & 8:

1. Characteristics shown for warm white based on 3000K and 80 CRI.
2. Characteristics shown for neutral white based on 4000K and 80 CRI.
3. Characteristics shown for cool white based on 5000K and 70 CRI.
4. For other color SKUs, the shift in color will vary. Please contact your Bridgelux Sales Representative for more information.

Performance Curves

Figure 9: Typical DC ccx Shift vs. Case Temperature

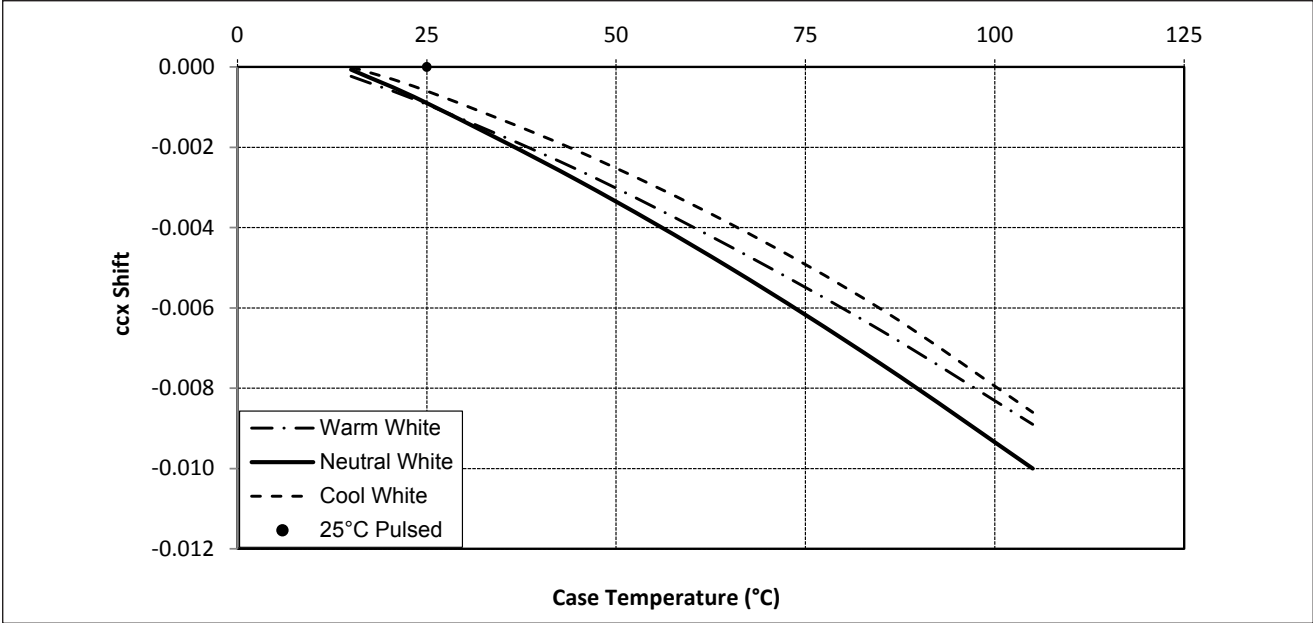

Notes for Figure 9:

- 1. Characteristics shown for warm white based on 3000K and 80 CRI.
- 2. Characteristics shown for neutral white based on 4000K and 80 CRI.
- 3. Characteristics shown for cool white based on 5000K and 70 CRI.
- 4. For other color SKUs, the shift in color will vary. Please contact your Bridgelux Sales Representative for more information.

Typical Radiation Pattern

Figure 10: Typical Spatial Radiation Pattern

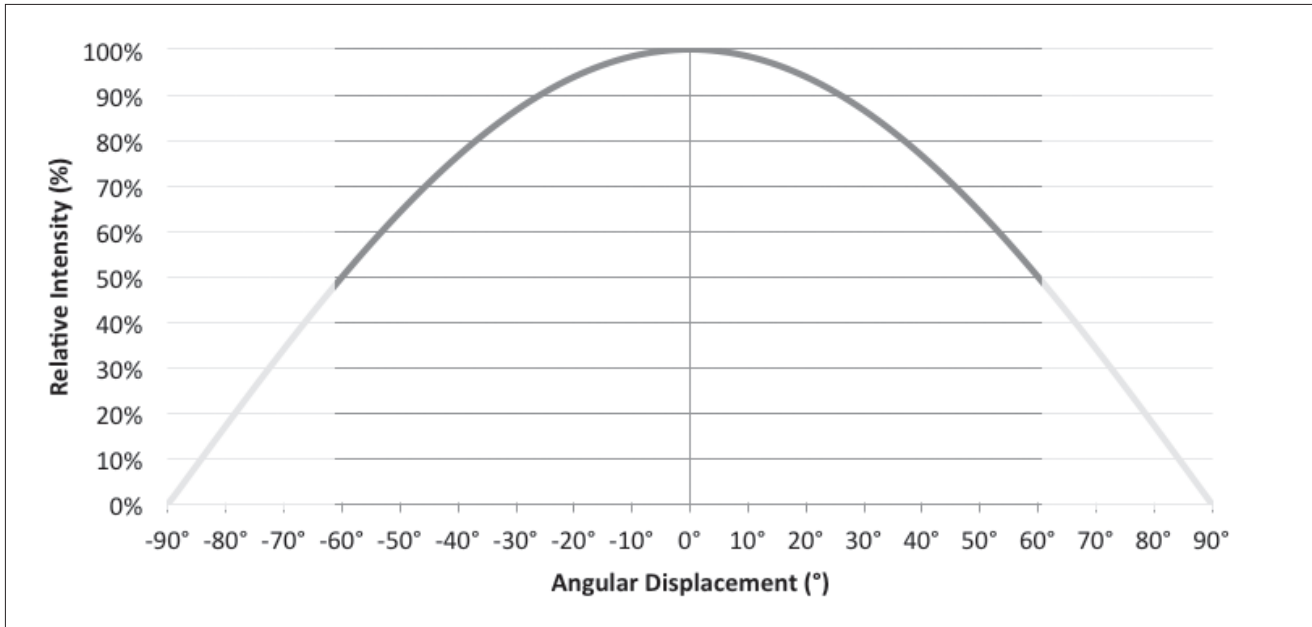

Note for Figure 10:

1. Typical viewing angle is 120°.
2. The viewing angle is defined as the off axis angle from the centerline where intensity is ½ of the peak value.

Figure 11: Typical Polar Radiation Pattern

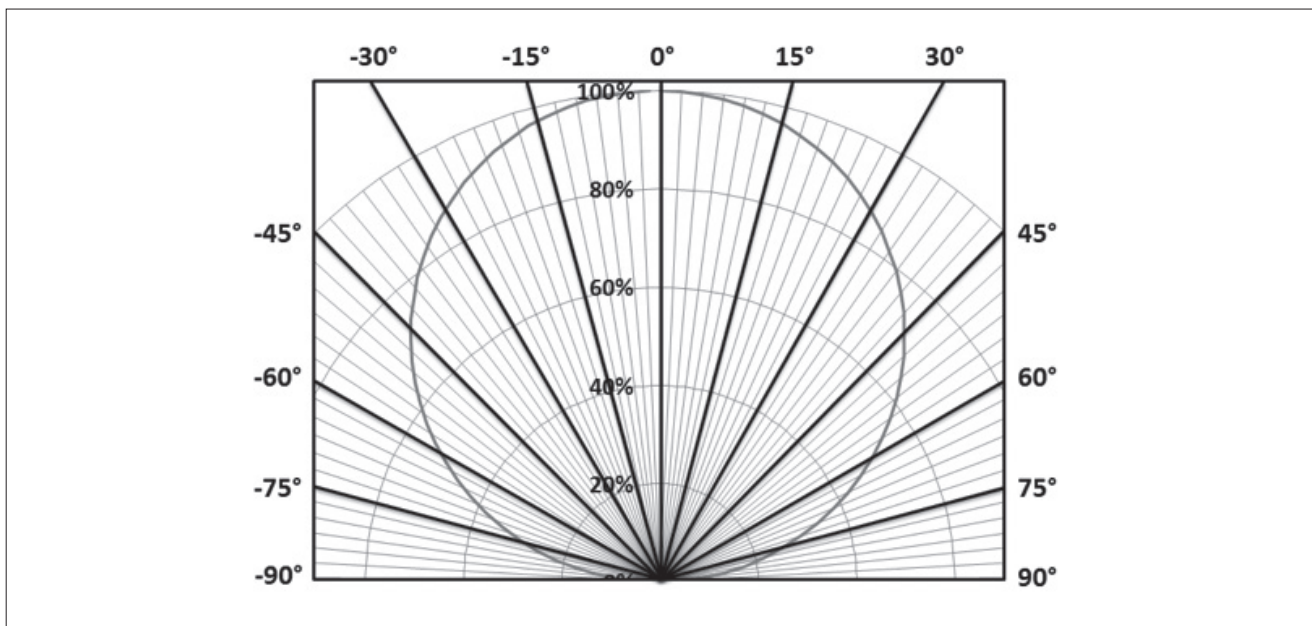

Typical Color Spectrum

Figure 12: Typical Color Spectrum

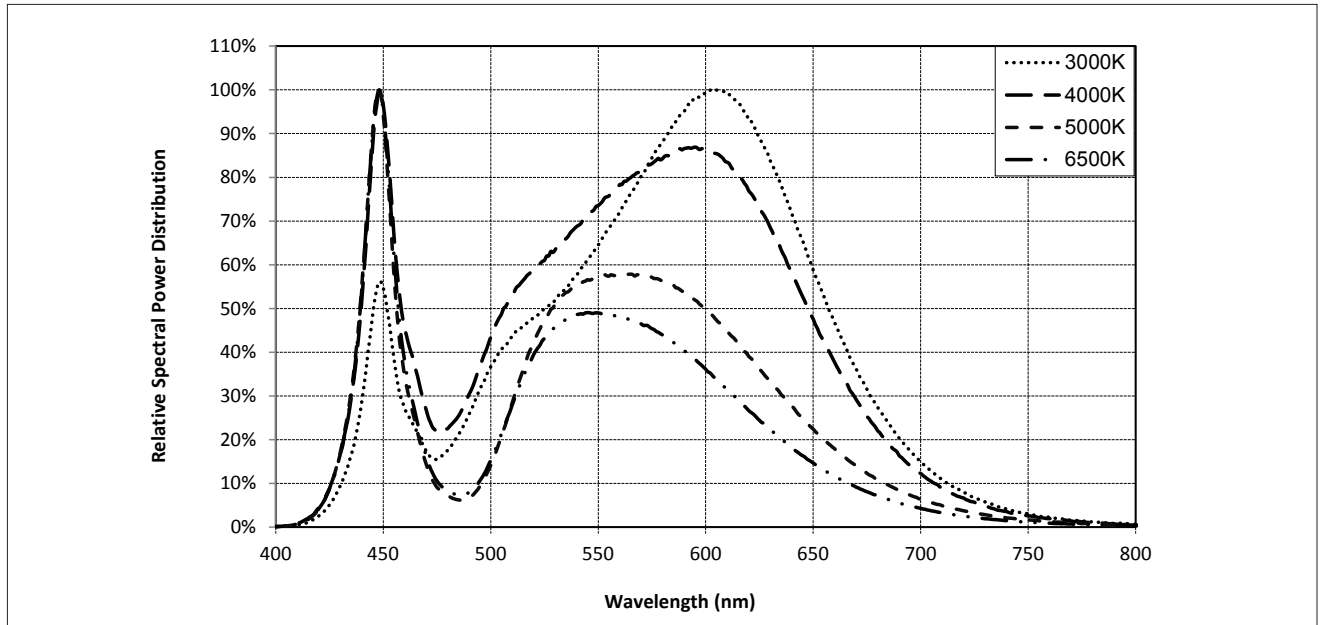

Note for Figure 12:

1. Color spectra measured at nominal current for $T_j = T_c = 25^\circ\text{C}$.
2. Color spectra shown is 3000K and 80 CRI.
3. Color spectra shown is 4000K and 80 CRI.
4. Color spectra shown is 5000K and 70 CRI.
4. Color spectra shown is 6500K and 70 CRI.

Mechanical Dimensions

Figure 13: Drawing for Vero 18 LED Array

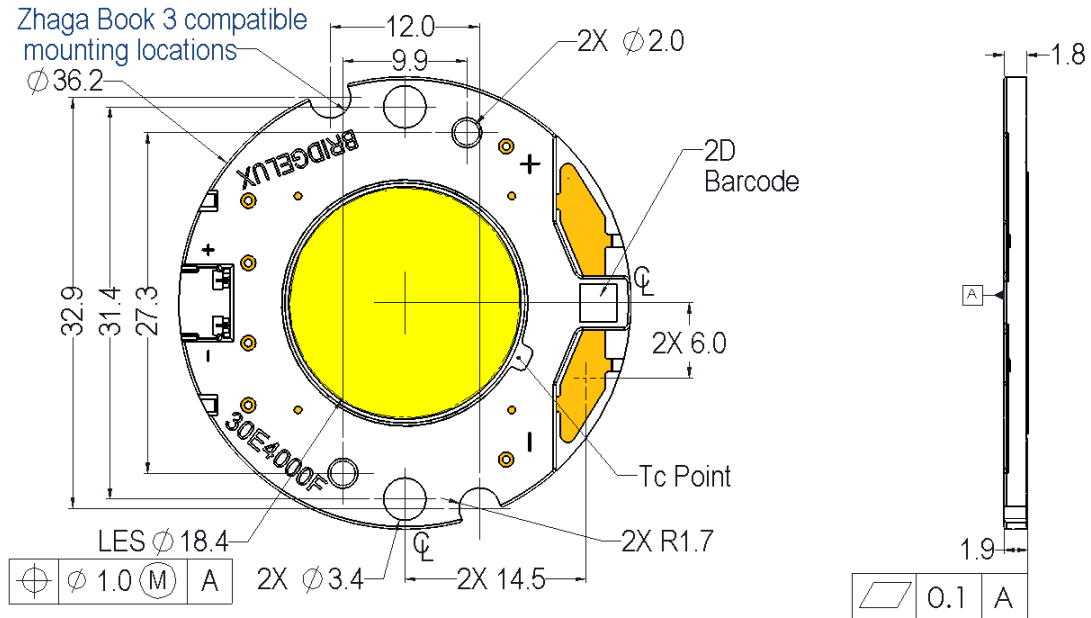

Notes for Figure 13:

1. Drawings are not to scale.
2. Drawing dimensions are in millimeters.
3. Unless otherwise specified, tolerances are $\pm 0.1\text{mm}$.
4. Mounting holes (2X) are for M2.5 screws.
5. Bridgelux recommends two tapped holes for mounting screws with $31.4 \pm 0.10\text{mm}$ center-to-center spacing.
6. Screws with flat shoulders (pan, dome, button, round, truss, mushroom) provide optimal torque control. Do NOT use flat, countersink, or raised head screws.
7. Solder pads and connector port are labeled "+" and "-" to denote positive and negative, respectively.
8. It is not necessary to provide electrical connections to both the solder pads and the connector port. Either set may be used depending on application specific design requirements.
9. Refer to Application Notes AN30 and AN31 for product handling, mounting and heat sink recommendations.
10. The optical center of the LED Array is nominally defined by the mechanical center of the array to a tolerance of $\pm 0.2\text{mm}$.
11. Bridgelux maintains a flatness of 0.10mm across the mounting surface of the array.

Color Binning Information

Figure 14: Graph of Warm and Neutral White Test Bins in xy Color Space

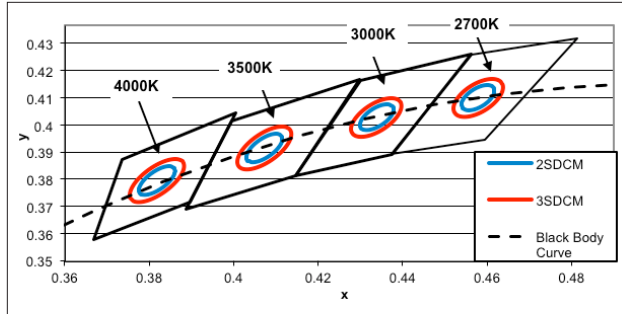

Note: Pulsed Test Conditions, $T_c = 25^\circ\text{C}$

Table 6: Warm and Neutral White xy Bin Coordinates and Associated Typical CCT

Bin Code	2700K	3000K	3500K	4000K
ANSI Bin (for reference only)	(2580K - 2870K)	(2870K - 3220K)	(3220K - 3710K)	(3710K - 4260K)
23 (3 SDCM)	(2651K - 2794K)	(2968K - 3136K)	(3369K - 3586K)	(3851K - 4130K)
22 (2 SDCM)	(2674K - 2769K)	(2995K - 3107K)	(3404K - 3548K)	(3895K - 4081K)
Center Point (x,y)	(0.4578, 0.4101)	(0.4338, 0.403)	(0.4073, 0.3917)	(0.3818, 0.3797)

Figure 15: Graph of Cool White Test Bins in xy Color Space

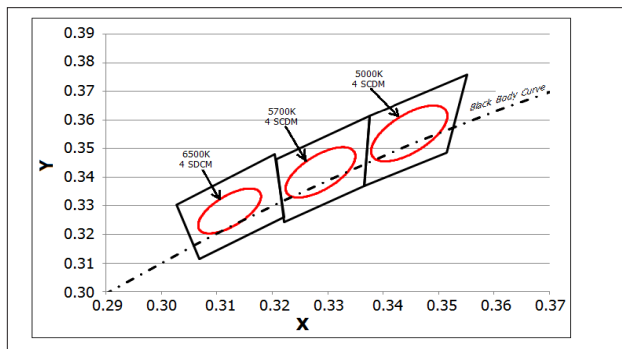

Note: Pulsed Test Conditions, $T_c = 25^\circ\text{C}$

Table 7: Cool White xy Bin Coordinates and Associated Typical CCT (product is hot targeted to $T_c = 85^\circ\text{C}$)

Bin Code	5000K	5700K	6500K
ANSI Bin (for reference only)	(4745K - 5311K)	(5312K - 6022K)	(6022K - 7042K)
4 (4 SDCM)	(4801K - 5282K)	(5829K - 5481K)	(6270K - 6765K)
Center Point (x,y)	(0.3447, 0.3553)	(0.3287, 0.3417)	(0.3123, 0.3282)

Packaging and Labeling

Figure 16: Drawing for Vero 18 Packaging Tray

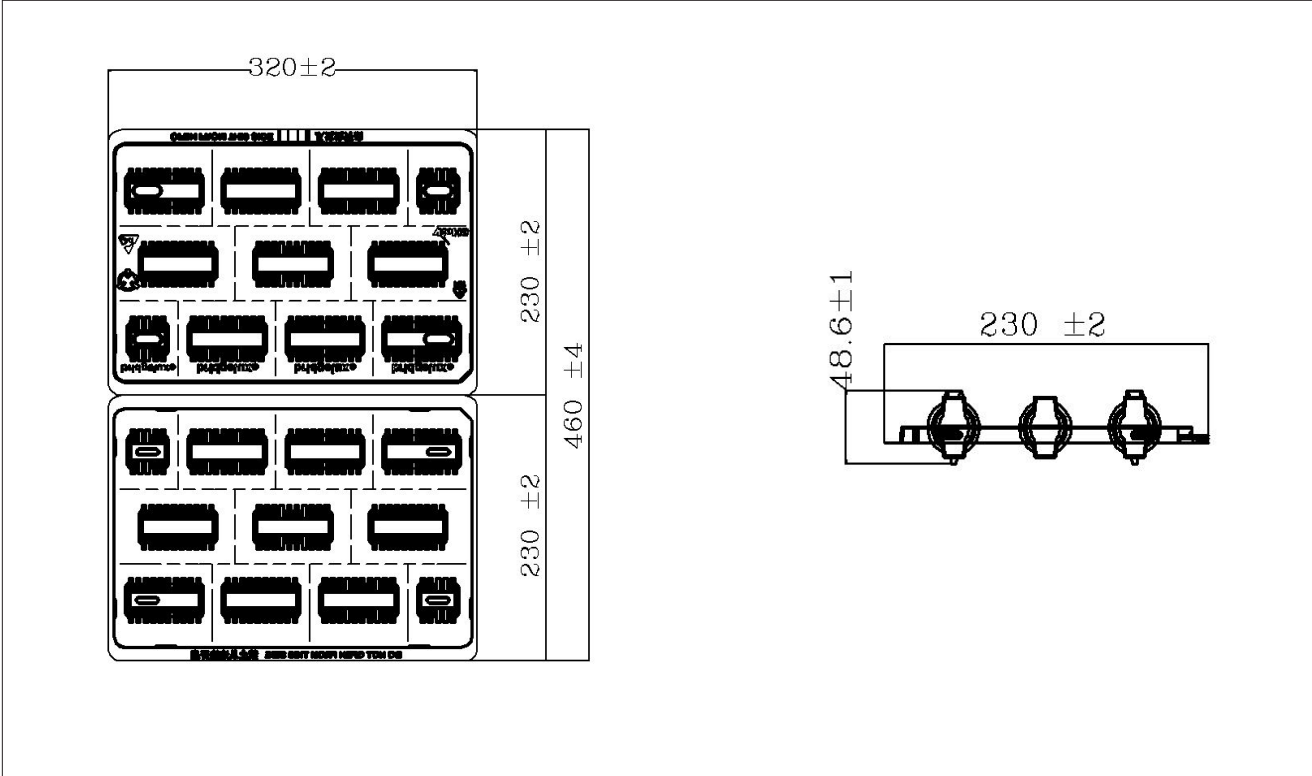

- Notes for Figure 16:
1. Dimensions are in millimeters.
 2. Drawings are not to scale.

Packaging and Labeling

Figure 17: Vero Series Packaging and Labeling

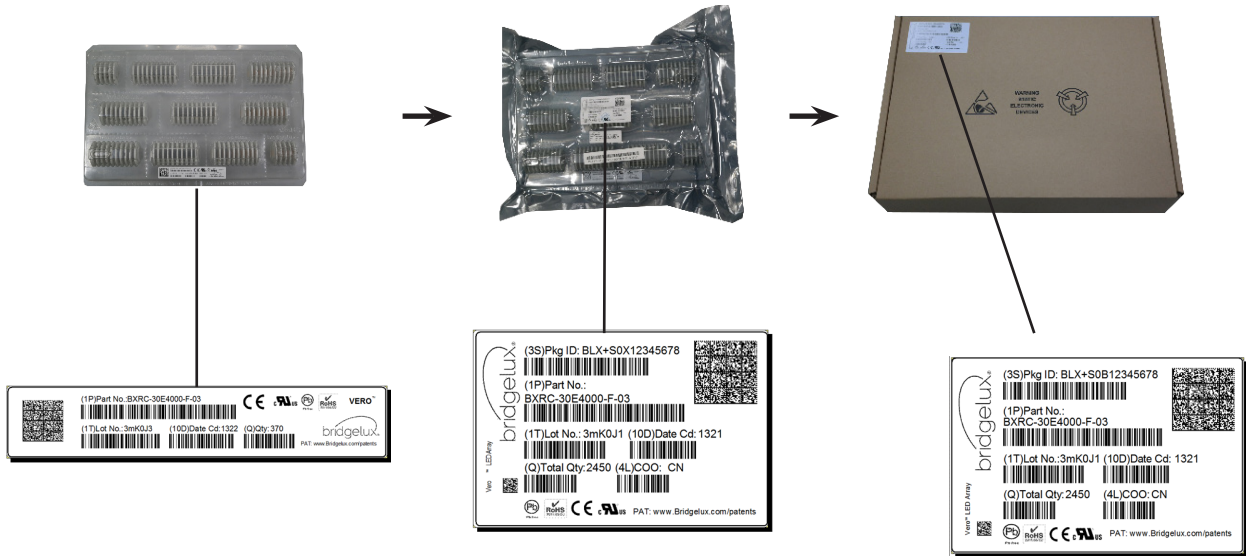

Notes for Figure 17:

1. Each tray holds 100 COBs.
2. Each tray is vacuum sealed in an anti-static bag and placed in its own box.
3. Each tray, bag and box is to be labeled as shown above.

Figure 18: Gen. 7 Product Labeling

Bridgelux COB arrays have laser markings on the back side of the substrate to help with product identification. In addition to the product identification markings, Bridgelux COB arrays also contain markings for internal Bridgelux manufacturing use only. The image below shows which markings are for customer use and which ones are for Bridgelux internal use only. The Bridgelux internal manufacturing markings are subject to change without notice, however these will not impact the form, function or performance of the COB array.



Design Resources

Application Notes

Bridgelux has developed a comprehensive set of application notes and design resources to assist customers in successfully designing with the Vero product family of LED array products. For all available application notes visit www.bridgelux.com.

Optical Source Models

Optical source models and ray set files are available for all Bridgelux products. For a list of available formats, visit www.bridgelux.com.

3D CAD Models

Three dimensional CAD models depicting the product outline of all Bridgelux Vero LED arrays are available in both IGS and STEP formats. Please contact your Bridgelux sales representative for assistance.

LM80

LM80 testing is ongoing. Please contact your Bridgelux sales representative for more information.

Precautions

CAUTION: CHEMICAL EXPOSURE HAZARD

Exposure to some chemicals commonly used in luminaire manufacturing and assembly can cause damage to the LED array. Please consult Bridgelux Application Note AN31 for additional information.

CAUTION: EYE SAFETY

Eye safety classification for the use of Bridgelux Vero Series LED arrays is in accordance with specification IEC/TR 62778: Application of IEC 62471 for the assessment of blue light hazard to light sources and luminaires. Vero Series LED arrays are classified as Risk Group 2 (Moderate Risk) when operated at or below 2.5 times the nominal drive current. The Ethr value is 889.79 lux per IEC/TR 62778. Please use appropriate precautions. **Under many operating conditions the Vero Series LED arrays are classified as Risk Group 1, for more information please contact your Bridgelux sales representative.** It is important that employees working with LEDs are trained to use them safely.

CAUTION: RISK OF BURN

Do not touch the Vero LED array during operation. Allow the array to cool for a sufficient period of time before handling. The Vero LED array may reach elevated temperatures such that could burn skin when touched

CAUTION

CONTACT WITH LIGHT EMITTING SURFACE (LES)

Avoid any contact with the LES. Do not touch the LES of the LED array or apply stress to the LES (yellow phosphor resin area). Contact may cause damage to the LED array.

Optics and reflectors must not be mounted in contact with the LES (yellow phosphor resin area). Optical devices may be mounted on the top surface of the plastic housing of the Vero LED array. Use the mechanical features of the LED array housing, edges and/or mounting holes to locate and secure optical devices as needed.

Disclaimers

MINOR PRODUCT CHANGE POLICY

The rigorous qualification testing on products offered by Bridgelux provides performance assurance. Slight cosmetic changes that do not affect form, fit, or function may occur as Bridgelux continues product optimization.

STANDARD TEST CONDITIONS

Unless otherwise stated, array testing is performed at the nominal drive current.

About Bridgelux: We Build Light That Transforms

At Bridgelux, we help companies, industries and people experience the power and possibility of light. Since 2002, we've designed LED solutions that are high performing, energy efficient, cost effective and easy to integrate. Our focus is on light's impact on human behavior, delivering products that create better environments, experiences and returns—both experiential and financial. And our patented technology drives new platforms for commercial and industrial luminaires.

For more information about the company, please visit
bridgelux.com
twitter.com/Bridgelux
facebook.com/Bridgelux
WeChat ID: BridgeluxInChina



101 Portola Avenue
Livermore, CA 94551
Tel (925) 583-8400
Fax (925) 583-8410
www.bridgelux.com

© 2016 Bridgelux, Inc. All rights reserved 2016. Product specifications are subject to change without notice. Bridgelux, the Bridgelux stylized logo design and Vero are registered trademarks, and Decor Series is a trademark of Bridgelux, Inc. All other trademarks are the property of their respective owners.

Bridgelux Gen 7 Vero 18 Array Series Product Data Sheet DSg2 Rev. C (07/2016)